



[sales@allsportsystems.com](mailto:sales@allsportsystems.com)

877-847-1280

[www.allsportsystems.com](http://www.allsportsystems.com)

# SETUP GUIDE FOR THE BudgetBay™ Golf Simulator Screen Systems



**IMPORTANT WARNING: USE THIS PRODUCT AT YOUR OWN RISK. NO CLAIM IS MADE AS TO ITS SAFETY, FITNESS, OR RELIABILITY FOR ANY PURPOSE. HITTING GOLF BALLS IN AN INDOOR ENVIRONMENT IS EXTREMELY DANGEROUS! ALWAYS EXERCISE CAUTION WHEN USING YOUR SYSTEM. WE RECOMMEND HITTING 'ALMOST GOLF' BALLS OR SIMILAR LIGHT WEIGHT GOLF BALLS FOR INCREASED SAFETY. NEVER SWING A GOLF CLUB IN CLOSE PROXIMITY TO PETS OR PEOPLE. ALWAYS STAND AS CLOSE AS POSSIBLE TO THE HITTING BAY TO MINIMIZE THE RISK OF STRAY SHOTS FLYING OUTSIDE THE ENCLOSURE. NEVER ALLOW ANYONE TO STAND IN FRONT OF YOU, OR ON EITHER SIDE OF THE ENCLOSURE WHILE YOU ARE HITTING!**

# Table of Contents

<b>ITEMS YOU WILL NEED</b>	<b>4</b>
<b>MEASURING AND CUTTING EMT POLES</b>	<b>5</b>
<b>ITEMS PROVIDED BY ALLSPORTSYSTEMS</b>	<b>6</b>
<b>BUILDING THE FRAME</b>	<b>8</b>
<b>PROJECTION SCREEN INSTALLATION</b>	<b>13</b>
<b>BLACKOUT™ PANEL INSTALLATION</b>	<b>16</b>
<b>SAFETY PRECAUTIONS</b>	<b>18</b>
<b>APPENDIX A - BUILDING THE FRAME (For Low Ceilings)</b>	<b>19</b>
<b>APPENDIX B - EMT POLE SCHEMATIC</b>	<b>27</b>

## ITEMS YOU WILL NEED

For safety we recommend at least two persons to be on hand to assemble your hitting enclosure.

### Tools/Equipment

- Six foot step ladder
- Screwdriver
- Hacksaw/Tubing Cutter (or ask the store to cut the EMT poles for you)
- Scissors/Utility Knife
- Measuring Tape
- Pencil

### Building Materials Not Included

The following items are not included and must be obtained locally.

- **¼ inch chain**  
Chain only needed if you received the shot defender, cut to width of your enclosure minus 9 inches.
- **Metal EMT Poles**  
1" diameter, 10' long EMT conduit poles from any major local hardware store. For quantity and lengths needed see chart on the following page.



### Trade Size Designator: 1" diameter, metallic EMT 10-ft Conduit

Actual Size: Outside diameter is approximately 1 3/16", see [Appendix B](#)

- **Unistrut™ or SuperStrut™ Channel**

Only for customers ordering SkyBridge™ or SkyRailPlus™ cage attached projector mount. [1 5/8" x 7/8"] or [1 5/8" x 13/16"], 10' long channels can be purchased from any major local hardware store. SkyBridge™ customers must substitute the screen EMT pole for Unistrut™ or SuperStrut™ Channel. SkyRailPlus™ customers will need to substitute the screen EMT pole and front width EMT pole. Be sure to read the respective [user guides](#) if you have ordered either of these upgrades. Unistrut™ and SuperStrut™ are trade names of the same product.



[If you purchased a pre-cut EMT Pipe Kit, click here to view our setup guide on connecting your precut poles.](#)

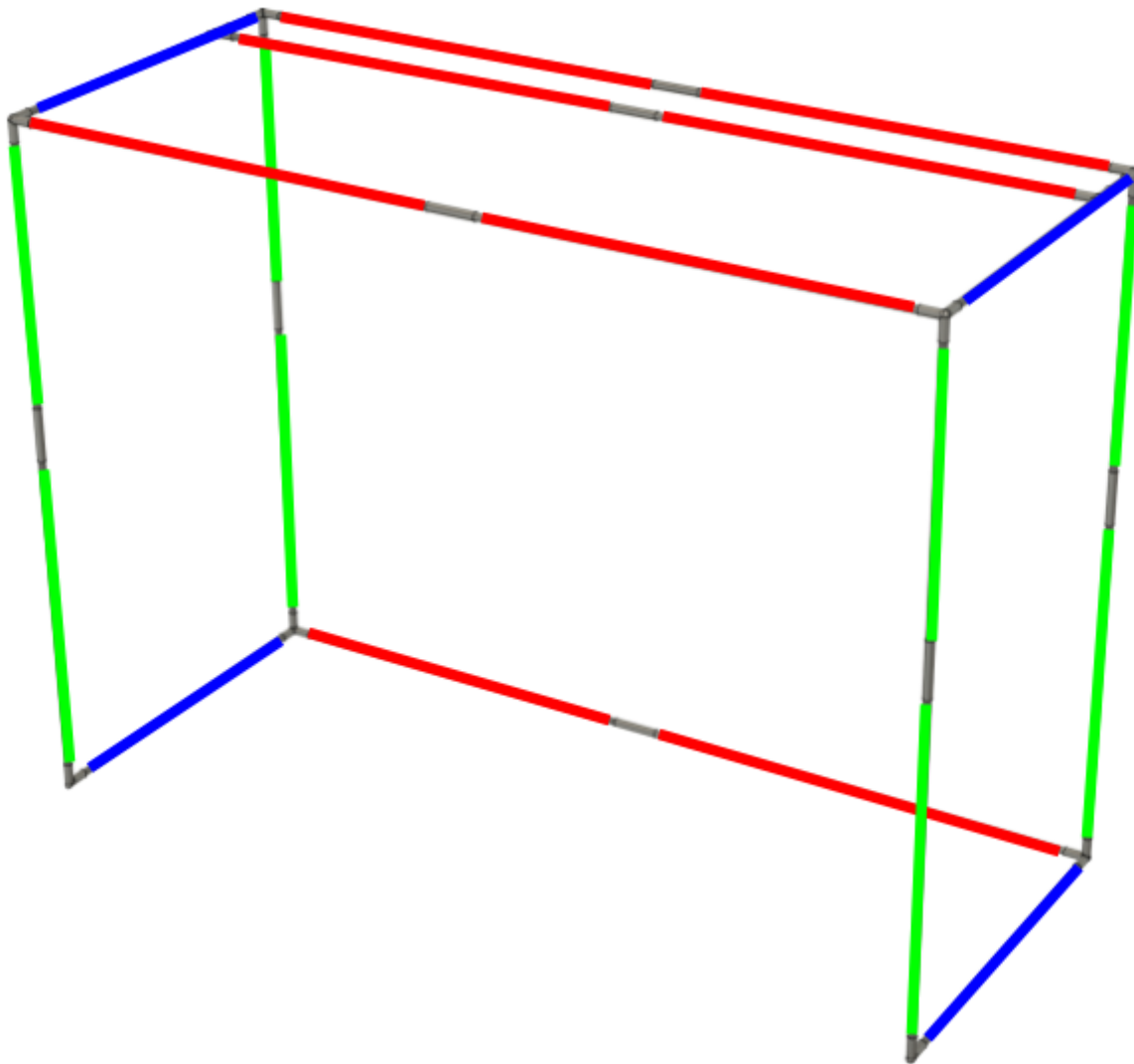

## MEASURING AND CUTTING EMT POLES

**Note:** Corner brackets add approximately 3” to the depth, height and width of your enclosure, thus poles are cut 3” shorter than the enclosure dimension as shown below. If you have questions about the number of poles needed for custom sized bays call us at 877-847-1280 for assistance.

### Poles for standard sized bays:

**NOTE:** SkyBridge™ and SkyRailPlus™ customers should first review the respective [setup guides](#) for these products as they will reduce the number of EMT poles needed.

Hitting Bay Size	Number of 10' long poles	Cut poles as follows:
<b>BudgetBay™</b> 10W x 9H x 5D	10 poles	Height: <b>4 poles</b> cut to 8'9" ea. Width: <b>4 poles</b> cut to 9'9" ea. Extender: none needed Depth: <b>2 poles</b> cut into 4 poles 4'9" ea.
<b>BudgetBay™</b> 12W X 9H x 5D	11 poles	Height: <b>4 poles</b> cut to 8'9" ea. Width: <b>4 poles</b> at 10'0" (no cuts needed) Extender: <b>1 pole</b> cut into 4 poles 1'9" ea. Depth: <b>2 poles</b> cut into 4 poles 4'9" ea.
<b>BudgetBay™</b> 14W x 9H x 5D	12 poles	Height: <b>4 poles</b> cut to 8'9" ea. Width: <b>4 poles</b> at 10'0" (no cuts needed) Extender: <b>2 poles</b> cut into 4 poles 3'9" ea. Depth: <b>2 poles</b> cut into 4 poles 4'9" ea.
<b>BudgetBay™</b> 16W x 9H x 5D	14 poles	Height: <b>4 poles</b> cut to 8'9" ea. Width: <b>4 poles</b> at 10'0" (no cuts needed) Extender: <b>4 poles</b> cut to 5'9" ea. Depth: <b>2 poles</b> cut into 4 poles 4'9" ea.

### Poles for custom sized bay:

If you have ordered a custom dimension bay use the information below to calculate the number of 10ft EMT poles needed and cut them to the proper length:





<b>HEIGHT POLES</b>	You will need 4 ea 10ft EMT poles - cut ea 3 inches shorter than your finished height
<b>WIDTH AND EXTENDER POLES</b>	<u>For bay 10ft or less</u> - you will need 4 ea 10ft EMT poles - cut ea 3 inches shorter than your finished width. <u>For bays 11 to 15ft</u> - you will need 5 ea 10ft EMT poles - cut one pole into 4 sections to extend the other 10ft poles to your finished width minus 3" inches. (i.e. a 13ft wide bay would require 4 ea 10ft poles plus 4 ea extender poles ea 2ft 9in long).

<b>DEPTH POLES</b>	For bays 5 feet or less - you will need 2 ea EMT poles - cut poles into four sections ea 3 inches shorter than finished depth. For bays greater than 5 feet - you will need 4 ea EMT poles - cut each pole 3 inches shorter than your finished depth.
--------------------	---



## ITEMS PROVIDED BY ALLSPORTSYSTEMS

### CONNECTOR KITS:

Standard cage configurations do not include the SkyBridge™ span brackets. However, if you have ordered the **SkyBridge™** or **SkyRailPlus™** please see the respective list of connectors provided:

<b>3-Way</b>	<b>L-Corner</b>	<b>Coupler</b>	<b>T-Connector</b>	<b>SkyBridge™</b>
				
<b>STANDARD CAGE CONNECTORS</b>				<b>Optional Upgrade</b>
<b>STANDARD CAGE</b>		<b>UPGRADE - SkyBridge™</b>		<b>UPGRADE - SkyRailPLUS™</b>
6 EA 3-WAYS	2 EA L-CORNERS	4 EA 3-WAYS	2 EA L-CORNERS	4 EA 3-WAYS
4 EA COUPLERS	2 EA T-CONNECTORS	3 EA COUPLERS	2 EA SKYBRIDGE SPAN BRACKETS	4 EA L-CORNERS
2 EA T-CONNECTORS		2 EA SKYBRIDGE SPAN BRACKETS		2 EA COUPLERS
				4 EA SKYBRIDGE SPAN BRACKETS

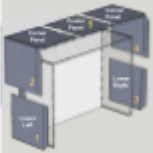
### OTHER ITEMS:

ITEM	QTY	DESCRIPTION
		Cable ties
	Multiple pieces	See <a href="#">BLACKOUT™ PANEL INSTALLATION</a>
	1 ea	Screen



2 ea Bungee Cords



**OPTIONAL UPGRADES:** The following items are included only if you have purchased these specific upgrades.

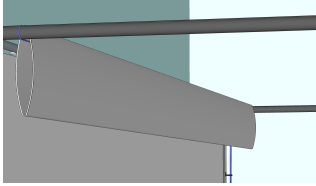

**ShotDefender™ Safety Guard** - This guard hangs from a steel cable just in front of the screen pole protecting it from ball strikes - see SuperBay™ [installation guide](#) for specific instructions for installation.



**SkyBridge™ Span Brackets** for strengthened screen pole (channel purchased separately) - see respective [user guide](#) for specific instructions for installation.



**SkyRailPLUS™ Sliding Projector Mount** installs in your cage - See respective [user guides](#) for specific instructions for installation.

## BUILDING THE FRAME

**NOTE:** SkyRailPlus™ and SkyBridge™ upgrades receive a different configuration of connectors. Review the chart above. Also be sure to review the respective [setup guide](#) for these upgrades.

### Frame Diagram

Refer to this diagram often to identify connectors and poles needed for the step by step instructions on the following pages. **Note** that the 10 Wide BudgetBay™ does not use couplers. Couplers are used to extend the length of the width poles beyond 10 feet wide.

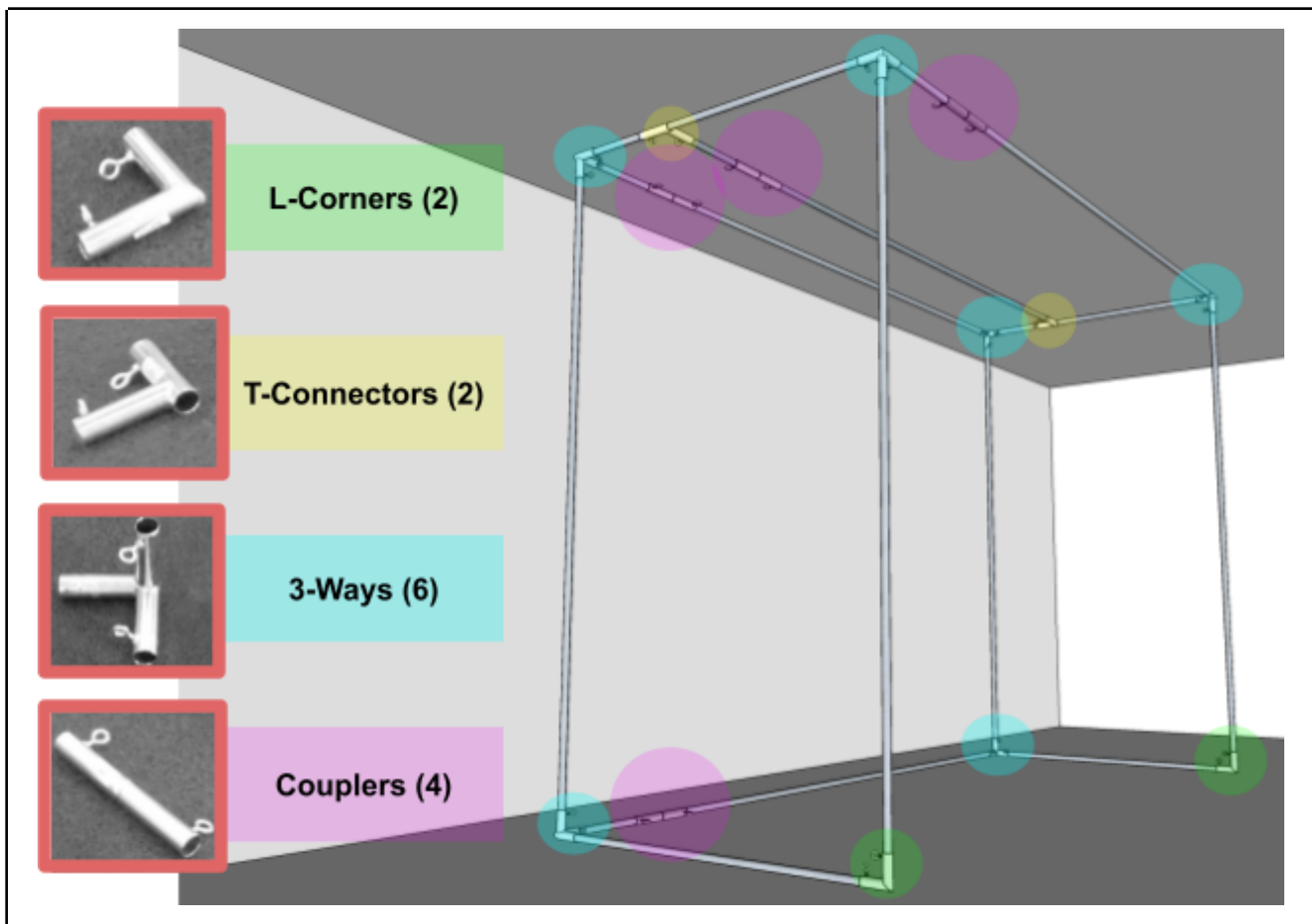

**Note:** Each corner bracket adds approximately 1.5" to the size of your enclosure. Therefore, once poles and brackets are assembled an additional 3" will be added to the finished width, height and depth of your enclosure. Therefore, all poles are cut 3" shorter than the finished height, width, or depth of the enclosure. *If you have ordered a **custom** sized enclosure make note of this factor when cutting your poles.*

## Step 1 - Build the frame

If hitting bay is closer than 6" to ceiling see [APPENDIX A - BUILDING THE FRAME](#) (For Low Ceilings). Two persons recommended and use of a stepladder. Position eye bolts inward. Verify correct width and depth when tightening connectors (may need to back poles slightly out of connectors to reach correct dimension).

- 1 For bays greater than 10ft wide, add extender poles to each of the four width poles using couplers.
- 2 Add two 3-ways to a width pole to form the bottom rear pole.
- 3 Insert two lower depth poles into rear 3-ways to form the frame bottom.
- 4 Insert two height poles into rear 3-ways.
- 5 Add two 3-ways to the top of the rear height poles
- 6 Insert top rear width pole to complete the back of the frame.
- 7 Insert two upper depth poles into the rear top 3-ways.
- 8 Slide two T-Connectors\* on each of the upper depth poles.  
**For SkyRailPlus™/SkyBridge™**  
T-Connectors are **not** needed
- 9 Add two L-Corners to the bottom depth poles.
- 10 Insert two front height poles into the L-Corners.

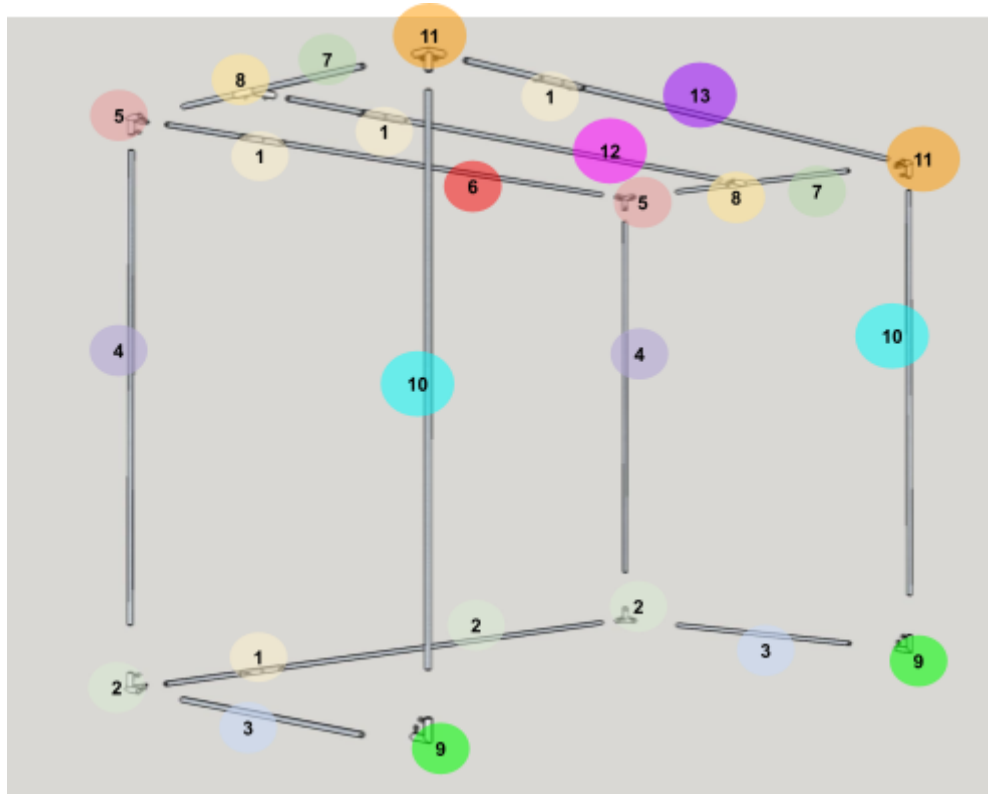

- 11 Add two 3-Ways to the front height poles.  
**For SkyRailPlus™**  
add two L-Corners instead.
- 12 Insert screen pole into the two T-Connectors.  
**For SkyRailPlus™/SkyBridge™**  
Use the SkyBridge™ bracket and unistrut. See SkyBridge™ [setup guide](#) for instructions on installing this pole.
- 13 Insert front width pole\* into front 3-Ways.  
**For SkyRailPlus™**  
Use the SkyBridge™ bracket and unistrut. See SkyBridge™ [setup guide](#) for instructions on installing this pole at the front of the cage.

## Step 2 - Position Screen Pole

Now slide the Screen Pole forward until it sits approximately 4 feet from the front pole leaving about 12" of space between the rear of the enclosure and the impact screen. Tighten the T-Connectors.

**SkyRailPlus™ Customers:** As noted in the [setup guide](#) for the SkyRailPlus™ the spacing between the front unistrut and screen unistrut should be exactly 4 feet. Improper spacing can cause the SkyRailPLUS™ to fall from the cage during installation. Be sure to take precautions until the mount is bolted securely in place.



### Step 3 - Check all connections and verify dimensions

- Proper positions of the poles and brackets for the BudgetBay™ frame are shown below.  
**Note** that the 10 Wide BudgetBay™ does not need extender poles. The Screen Pole should be approximately 12" from the back of the unit.
- Before proceeding, verify that all connectors are tight and outside dimensions are correct.  
Shown below is a 12 Wide BudgetBay™, 5' deep.



**CHECK ALL CONNECTIONS TO BE SURE THEY ARE TIGHTENED DOWN AND VERIFY OUTSIDE DIMENSIONS**  
BudgetBay™ - 10Wx9Hx5D or 12Wx9Hx5D or 14Wx9Hx5D or 16Wx9Hx5D

**IF YOU HAVE PURCHASED THE SKYRAILPLUS™ CAGE MOUNT IT SHOULD NOW BE MOUNTED ON THE CAGE, PRIOR TO THE INSTALLATION OF BLACKOUT™ WRAPPER**

## Step 4 - Install BlackOut™ Pole Sleeves

In the rare case that the BlackOut Wrapper Kit does not ship with the rest of the bay, continue with the rest of the installation. You have the option of using your system until the BlackOut™ kit arrives. More caution will be needed as the BlackOut panels provide some protection against stray balls.

Install pole sleeves on each of the four depth poles. Pole sleeves wrap around the pole and then velcro closed.

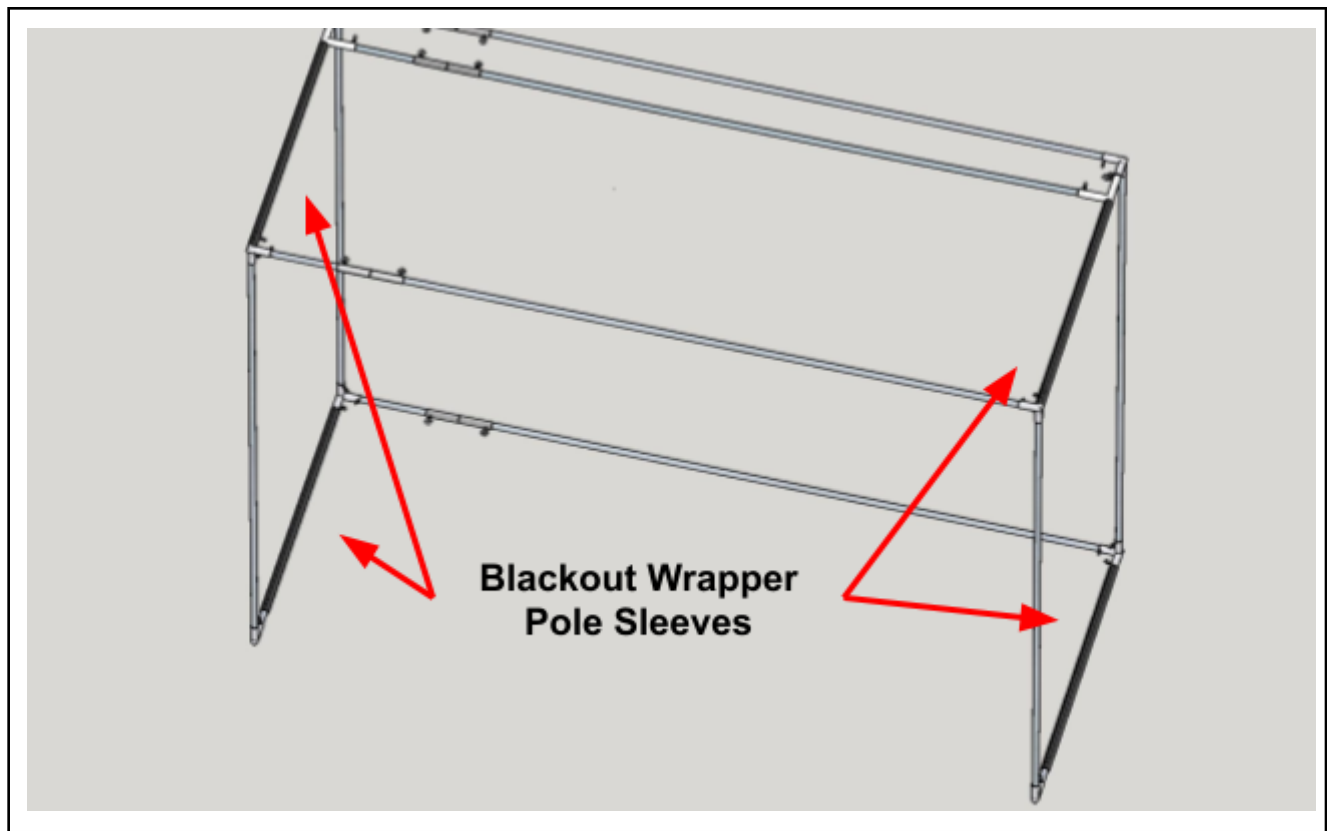

## PROJECTION SCREEN INSTALLATION

### Before hanging screen

**Creases:** Screen may have creases from being folded during shipment. These creases will lighten over time. If you wish, you can steam and/or iron the screen prior to hanging.

**Cleaning:** Over time your screen may become stained or marked from ball impacts. Your screen can be placed in the washing machine, use **MILD** detergent on gentle cycle,

**DO NOT USE BLEACH OR PLACE SCREEN IN DRYER**

### IDENTIFY THE FRONT SIDE of your screen:

The smooth face of the grommets will always be on the front side of your screen.

**DO NOT INSTALL THE SCREEN BACKWARDS!**  
**IT WILL SIGNIFICANTLY REDUCE THE LIFE OF THE SCREEN!**

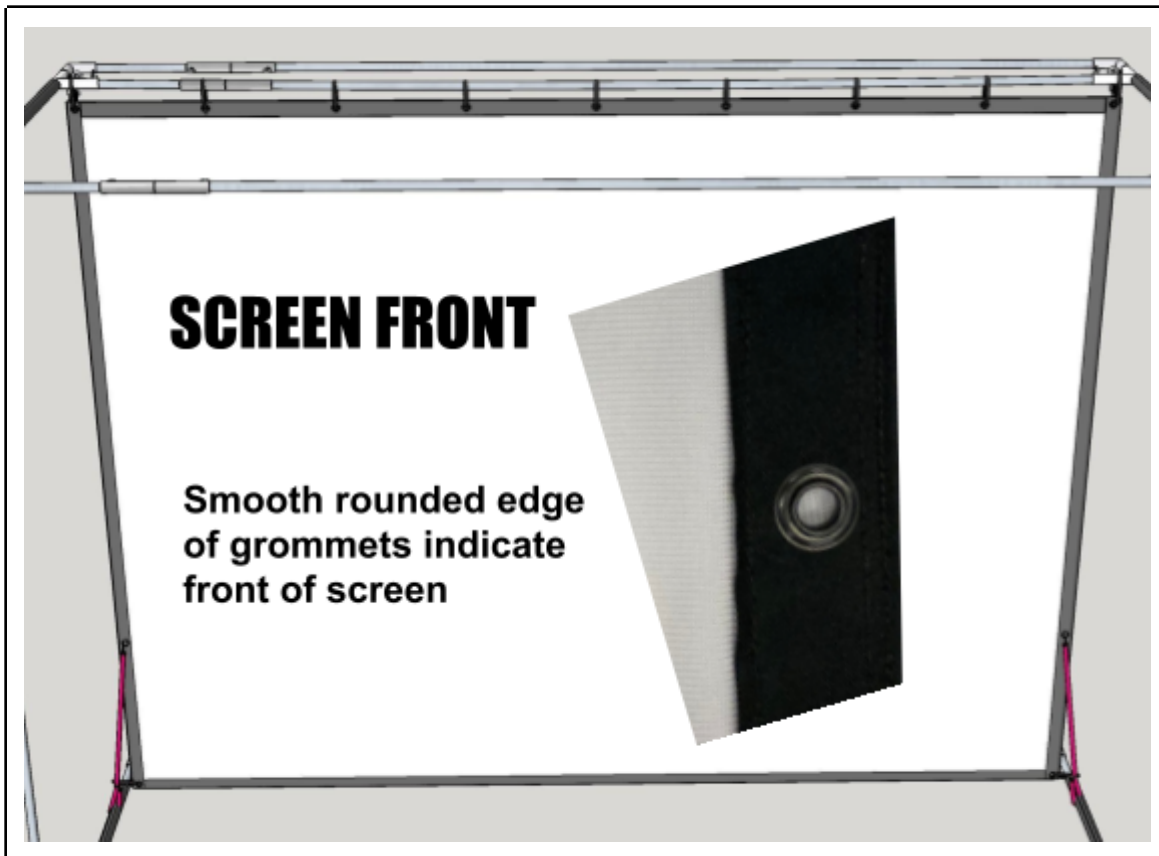

## Step 5 - Hang Screen

The Screen Pole should be 4 feet from the front of the enclosure.

**Upgrades:** If you purchased the OPTIONAL SideRite™ tension kit, see the SuperBay Installation Guide ([user guides](#)) for instructions on installation of your screen.

**Screen Front:** Be sure to hang the screen with the smooth side of grommet facing toward the front of the enclosure.

Using cable ties, loosely attach the screen to the Screen Pole.

**IMPORTANT:** To avoid screen sag and wrinkles, allow the screen to hang below the screen pole and even with the floor.

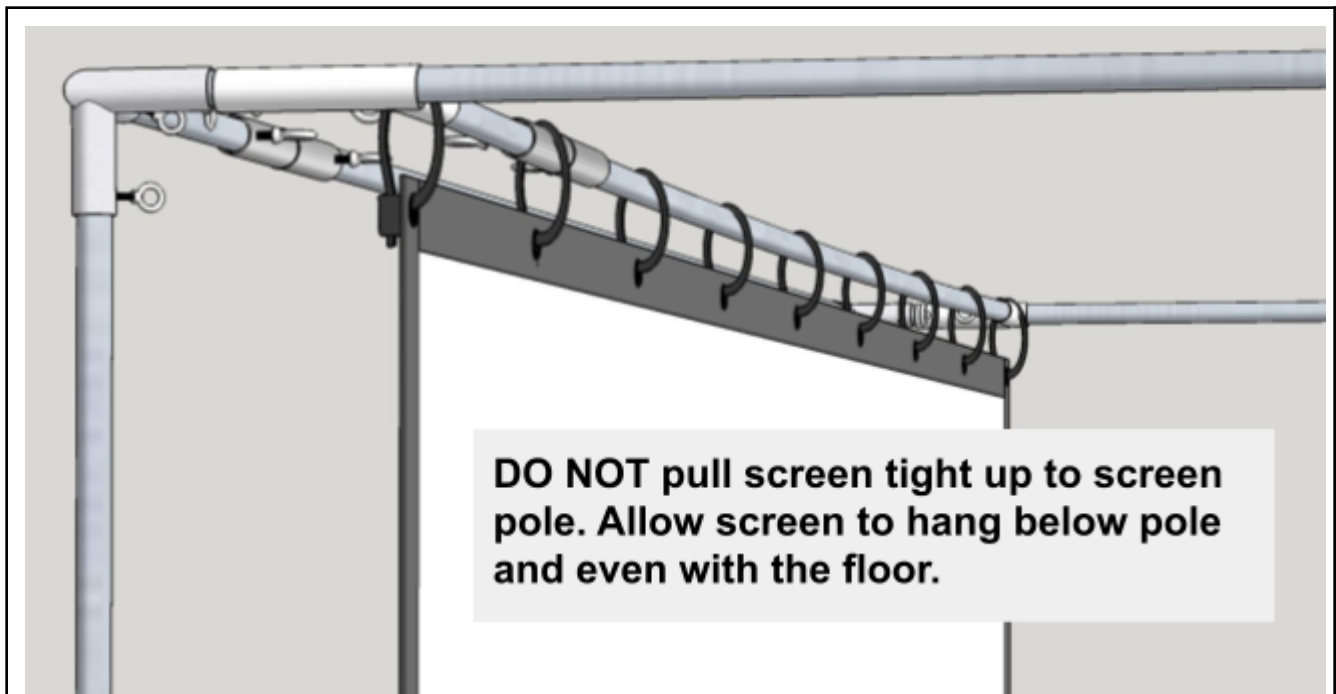



Attach bottom corners of screen to frame using cable ties. Use bungee cords to provide down tension to the screen.

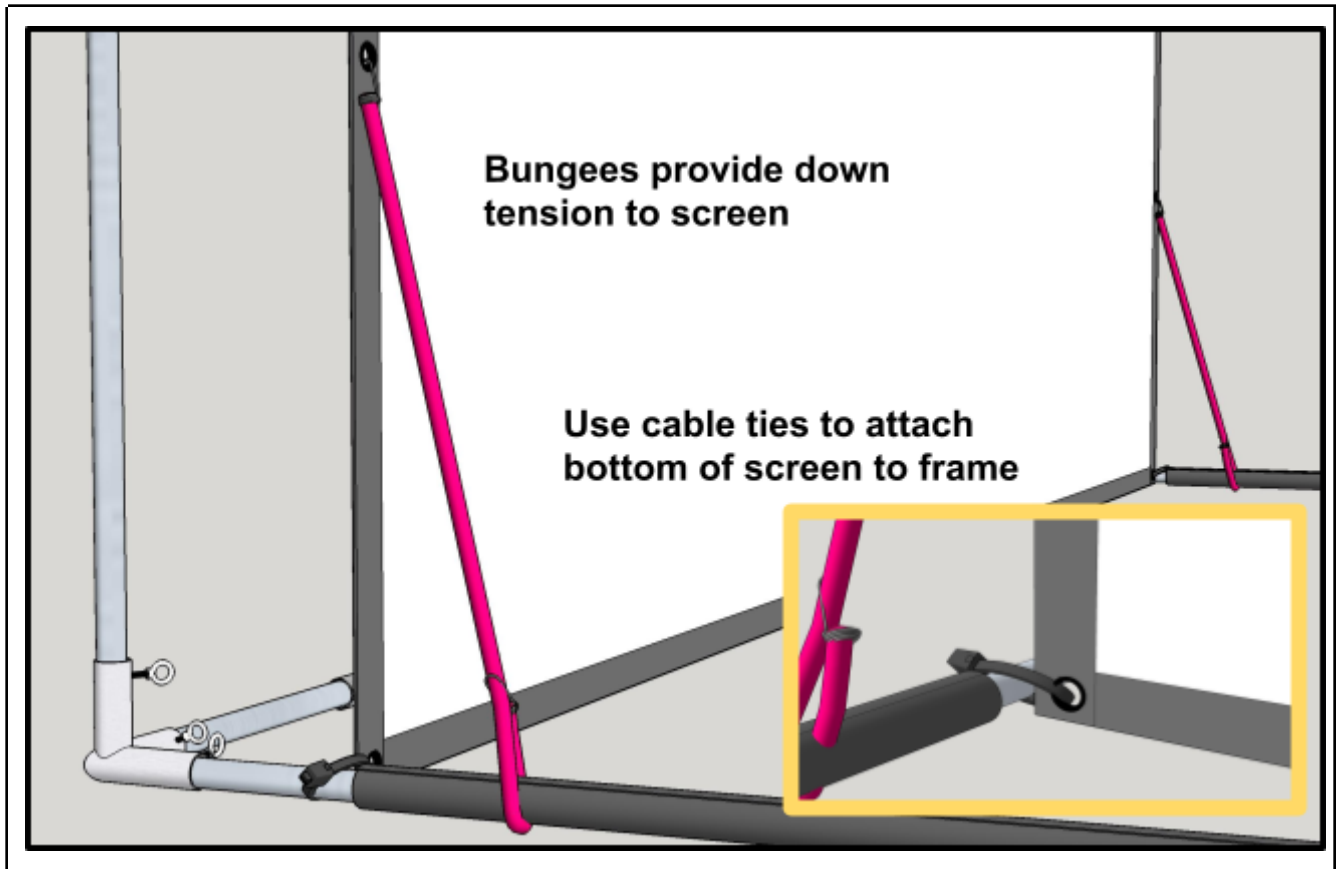

**Upgrades:** If you purchased the OPTIONAL ShotDefender™, see the SuperBay Installation Guide for instructions on installation.

User guides: <https://www.allsportsystems.com/setupguides.php>

# BLACKOUT™ PANEL INSTALLATION

## Step 7 - Install BlackOut Panels

You will receive six (6) panels. Orders with ShotDefender™ upgrade do not contain the valence as it is not needed. Location and order of panel installation is shown below:

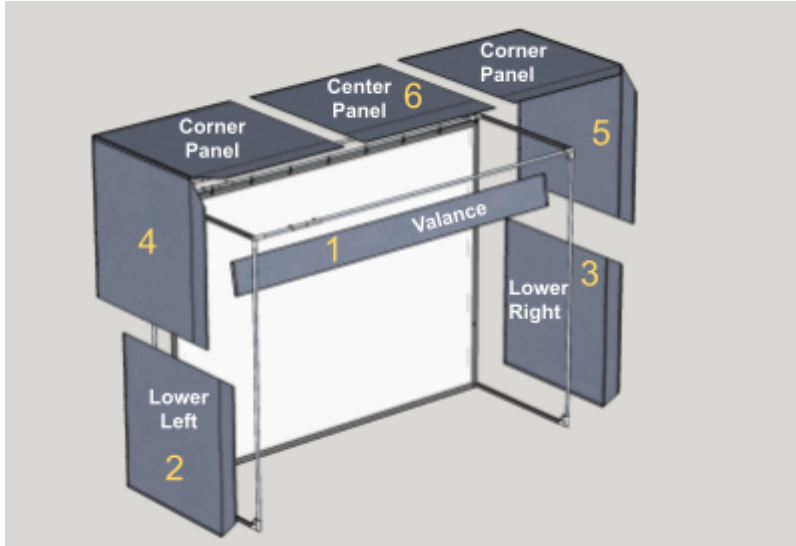

**Install panels in the number order shown.**

Panels are installed on the outside of the cage. To attach a panel to your cage, wrap the velcro edge around the front pole, attaching to the velcro strip on the inside of the panel. Next zip tie the panel to the rear pole through its grommets. Be sure not to over tighten the zip ties.

**STEP 1: Install the Valance:**

Drape the Valance over the screen pole so that half hangs evenly between the front and rear of the screen. Use cable ties to attach around the screen edge.

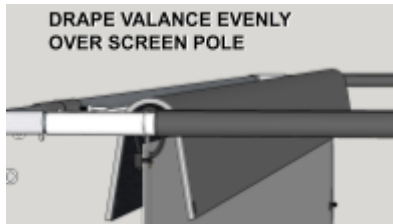

DRAPE VALANCE EVENLY OVER SCREEN POLE

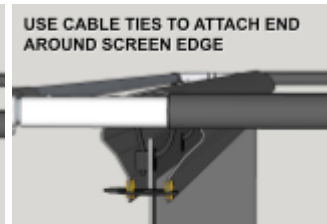

USE CABLE TIES TO ATTACH END AROUND SCREEN EDGE

**STEPS 2 & 3: Install Side Panels**

Attach via velcro strips and grommets with zip ties.

**STEPS 4 & 5: Install Corner Panels**

Attach via velcro strips and grommets with zip ties.

**STEP 6: Install Center Panel**

Panel will lay on top and overlap the corner panels. Attach via velcro strips and grommets with zip ties. Fold corners of leading edge (as shown) to prevent corners from dropping down where velcro isn't available due to the overlap.

**CENTER PANEL INSTALLATION**

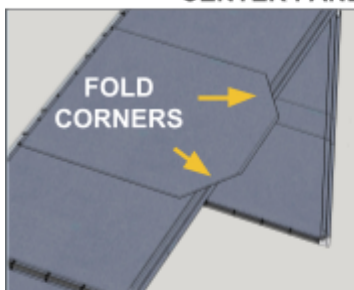

FOLD CORNERS

TOP VIEW

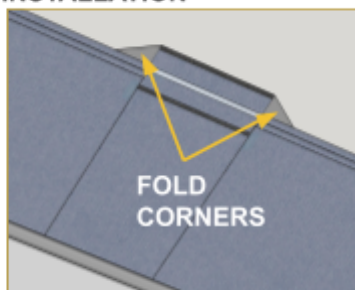

FOLD CORNERS

BOTTOM VIEW



Notched Center Panel for SkyRailPLUS

Customers with the **SkyRailPLUS** will receive a notched Center Panel which dresses the front of their cage around the SkyRailPLUS.

## Angled Side Netting (OPTIONAL UPGRADE)

- Attach your angled side netting using the velcro attached to the trim. Velcro will attach to the exposed velcro along the front edge of your side panels.
- Add weights to the two included sandbags.
- Use zip ties to attach the weighted sandbags to the ends of the Angled Side Netting.
- Pull the netting out, and adjust to your desired angle.



(SuperBay pictured above)

## SAFETY PRECAUTIONS

The BudgetBay™ is designed for the back of the enclosure to sit directly against a wall. However, we recommend positioning the sides of the enclosure no closer than 12" away from walls or other objects. Your screen is fully capable of handling real golf balls. *For added safety*, consider using "Almost Golf Balls", or foam balls rather than real golf balls when hitting indoors.



*Enjoy and be safe,*

**AllSportSystems**

## APPENDIX A - BUILDING THE FRAME (For Low Ceilings)

**NOTE:** This method is recommended for situations where the enclosure height is very close to your ceiling height. Two persons recommended for assembly. Position connectors so that the Eye Bolts face inward or down. **Verify Dimensions:** Throughout assembly verify correct width, height, and depth, then tighten connectors. You may need to back poles slightly out of connectors to reach correct dimension.

### Step 1 - Top Rear Width Pole

For BudgetBays™ greater than 10 feet wide, add Couplers to extend each of the four Width poles. Position a Width pole on the ground near your back wall. This will become your top rear width pole. Add two 3-Way Corners on each end.

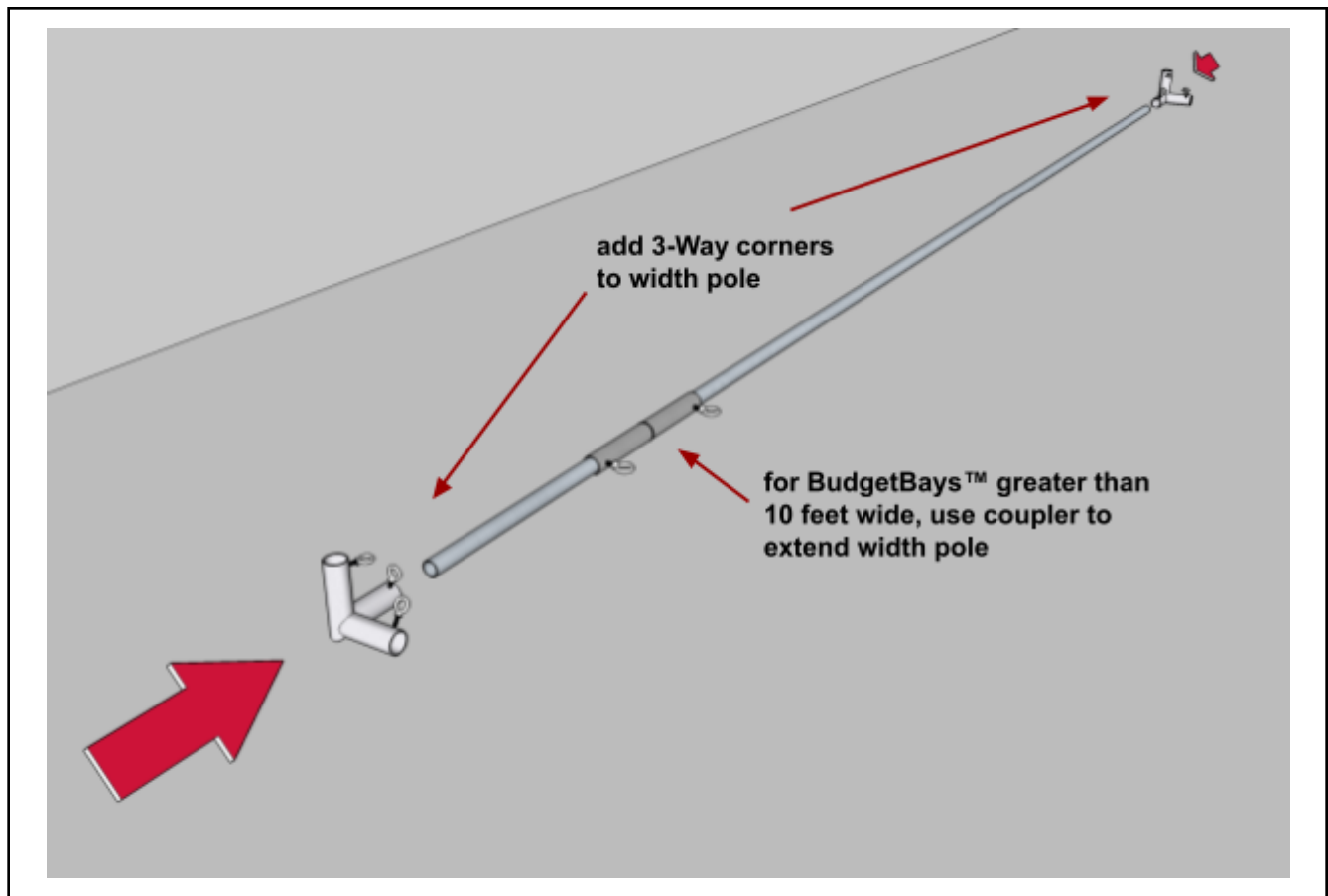

## Step 2 - Two Rear Height Poles

Leaving the pole on the ground, connect two Height poles to the 3-Way Corners and tighten connectors. Add two more 3-Way Corners to the other end of the Height Poles, but do not fully tighten these.

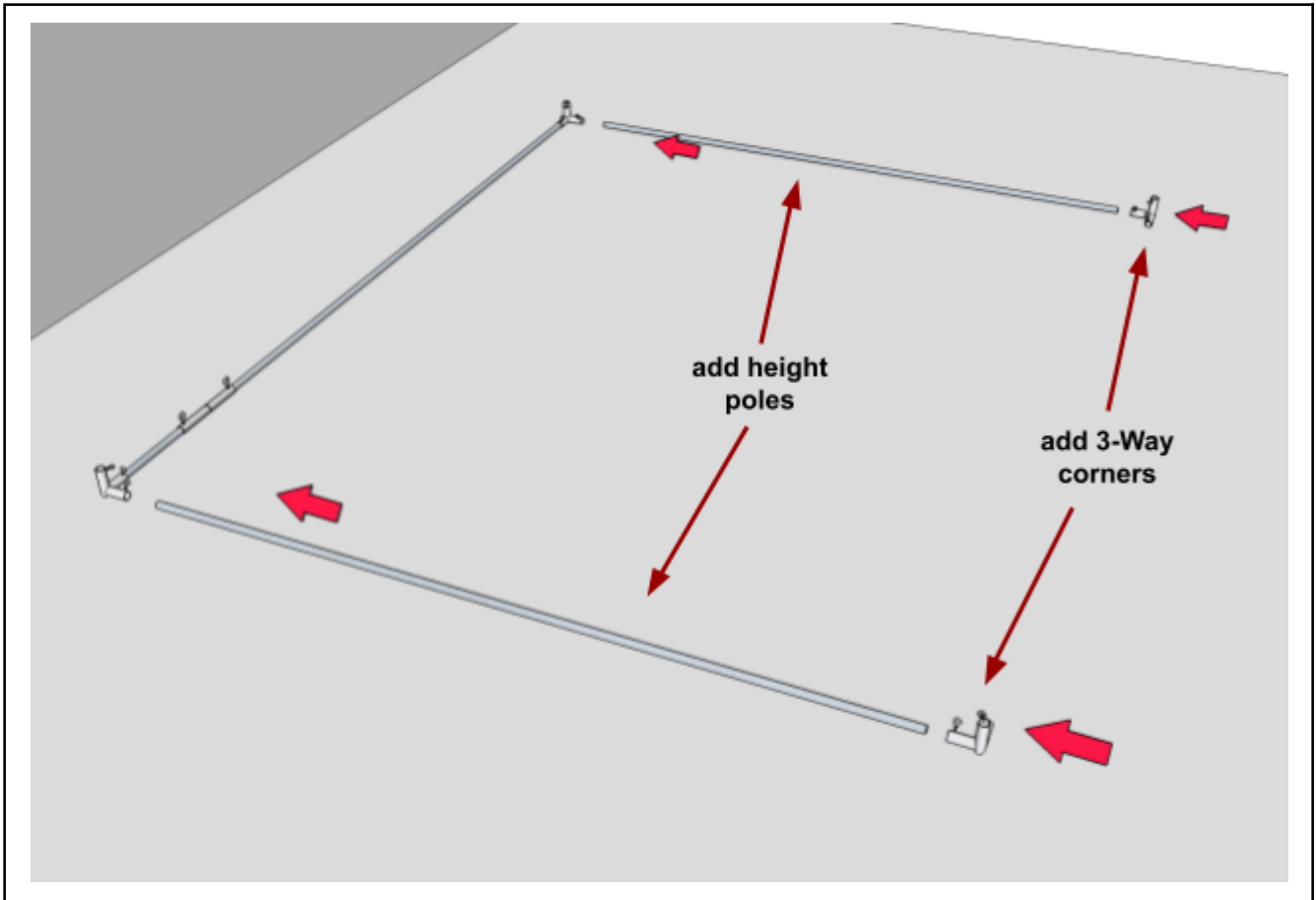

### Step 3 - Stand Rear Height Poles

**Tip:** Leaving the bottom 3-Way Corners loose will allow you to spin them when tilting the rear structure into place. Once it is in place you can then spin them into their proper orientation so as to install the bottom Width Pole.

With an assistant, carefully stand the structure up and lean it against the back wall of your room. The assistant should hold the frame in place securely against the wall.

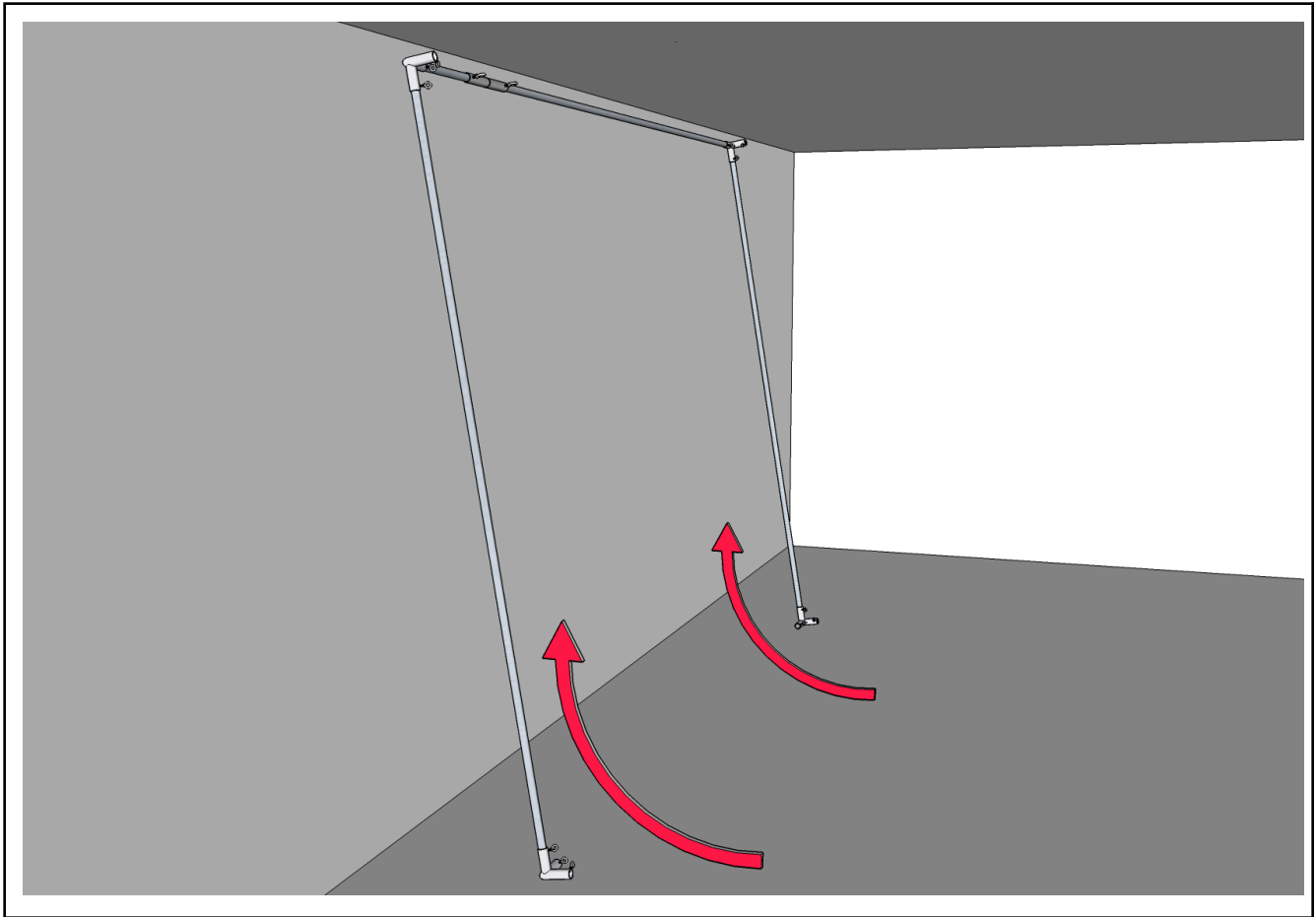

## Step 4 - Add Bottom Rear Width Pole

Next add the Bottom Width Pole. Continue to have an assistant steady the frame against the wall.

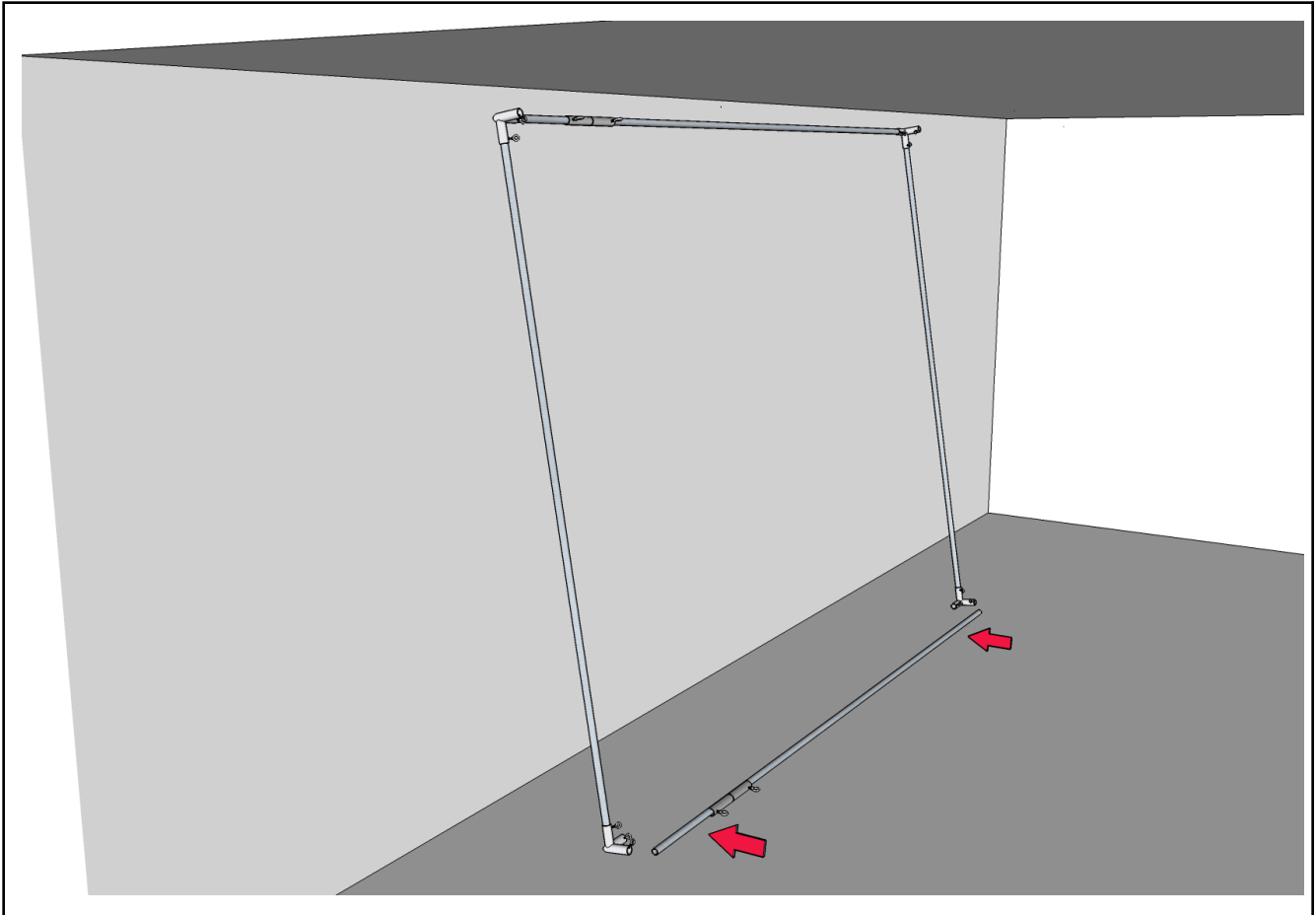



## Step 5 - Add Bottom Depth Poles

Insert two Depth poles into the Bottom Rear 3-Way Corners and tighten these connectors. The structure will now stand on its own.

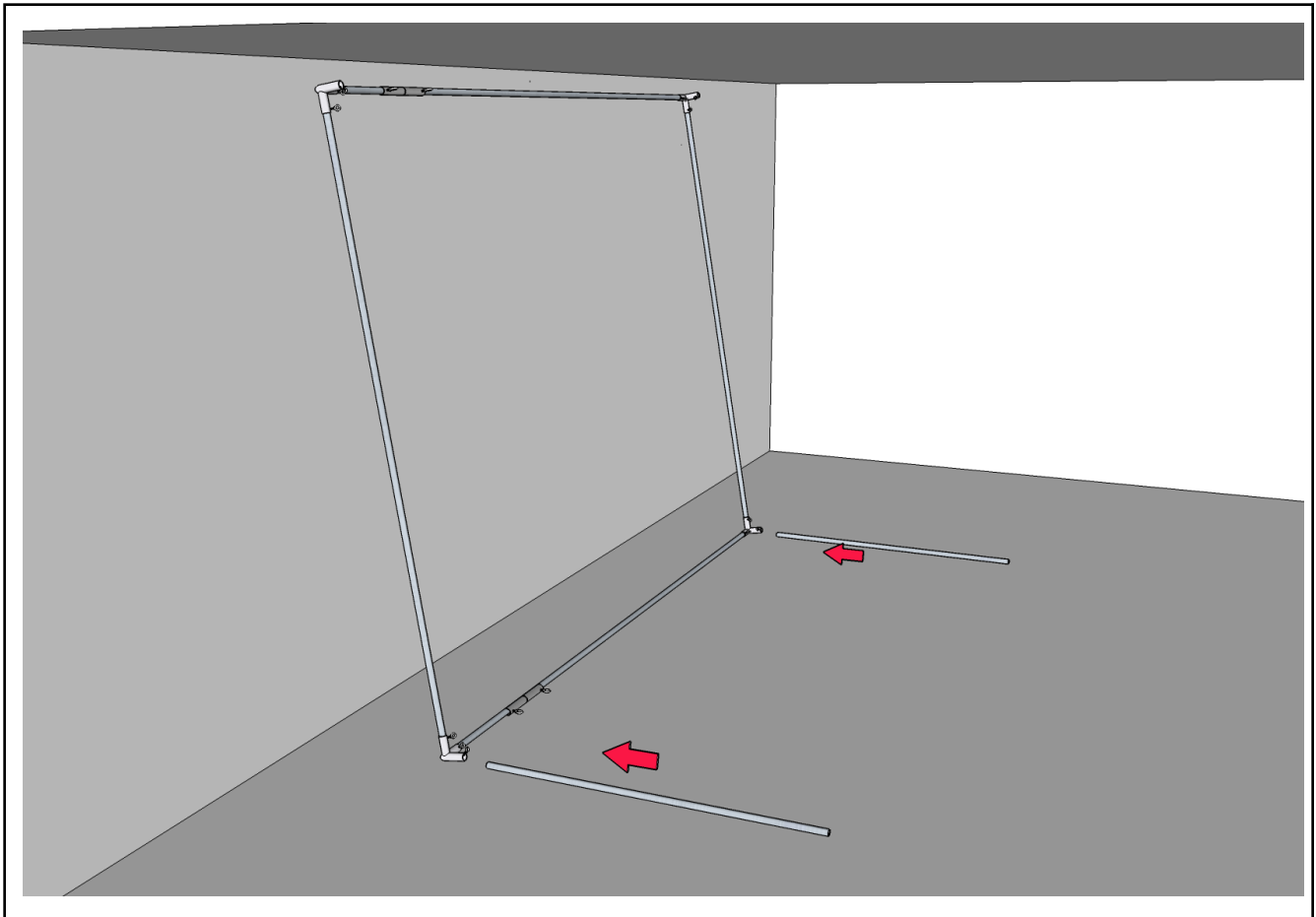

## Step 6 - Add Top Depth Poles and Screen Pole

Insert the two remaining Depth poles into the Top Rear 3-Way corners and tighten these connectors.

Slide a T-connector onto the front of each top Depth pole.

**For SkyRailPlus™/SkyBridge™ configurations** T-Connectors are not needed.

Insert WIDTH pole into T-Connectors. This will create the Screen pole where your screen will hang.

Temporarily slide the Screen Pole back toward the rear of the enclosure as far as possible, this will make installing the last width pole on the front of the enclosure easier.

**For SkyRailPlus™/SkyBridge™ configurations** see SkyBridge™ [setup guide](#) for instructions on installing this pole.

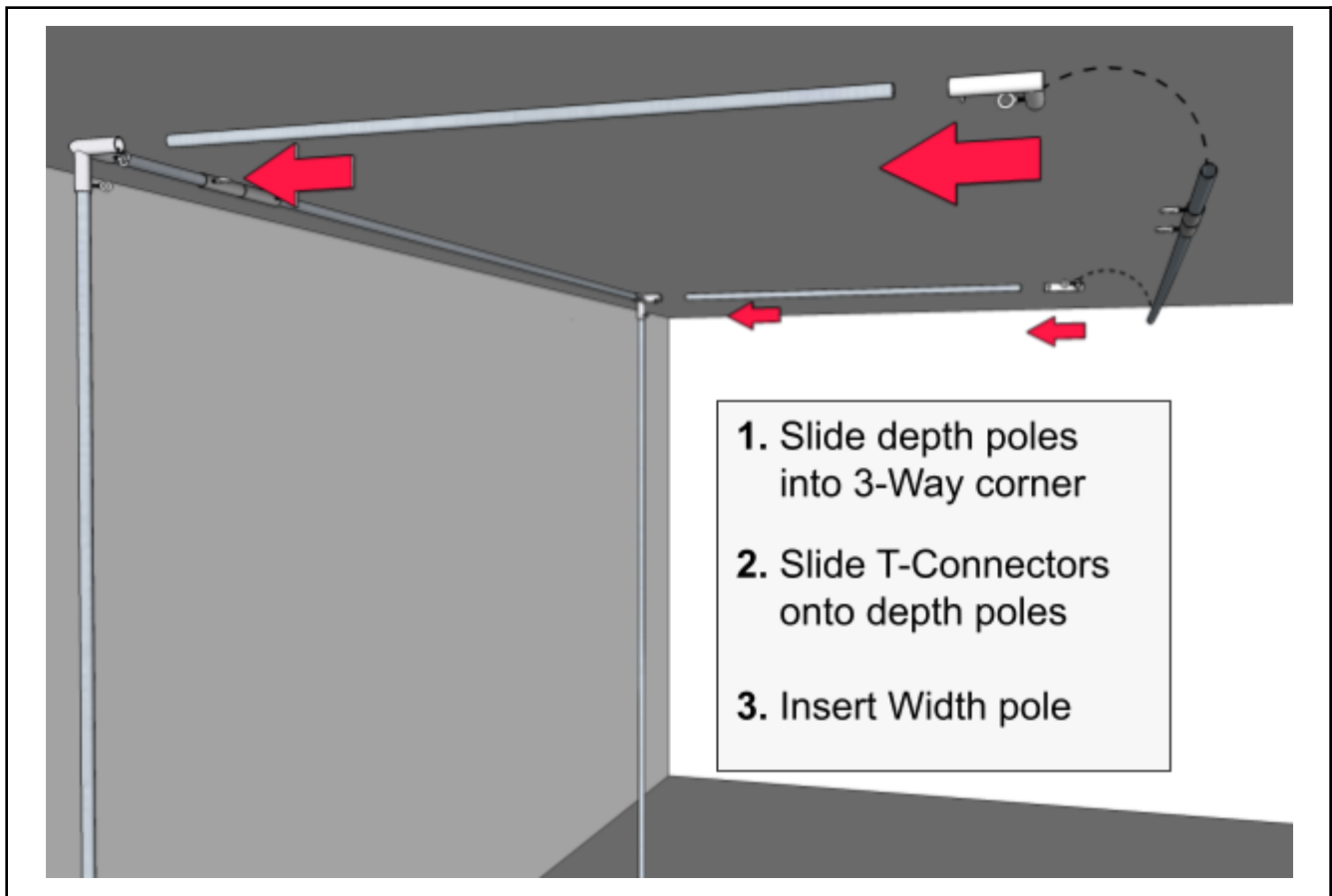

## Step 7 - Add Front Height Poles

With the front height poles - place 3-Way corners on one end and L Corners on the other end and connect the Height poles to the structure as shown with the three-way on top and L Corners on the bottom.

**For SkyRailPlus™** configurations add L-Corners to both ends of front height poles and connect to the lower and upper depth poles.

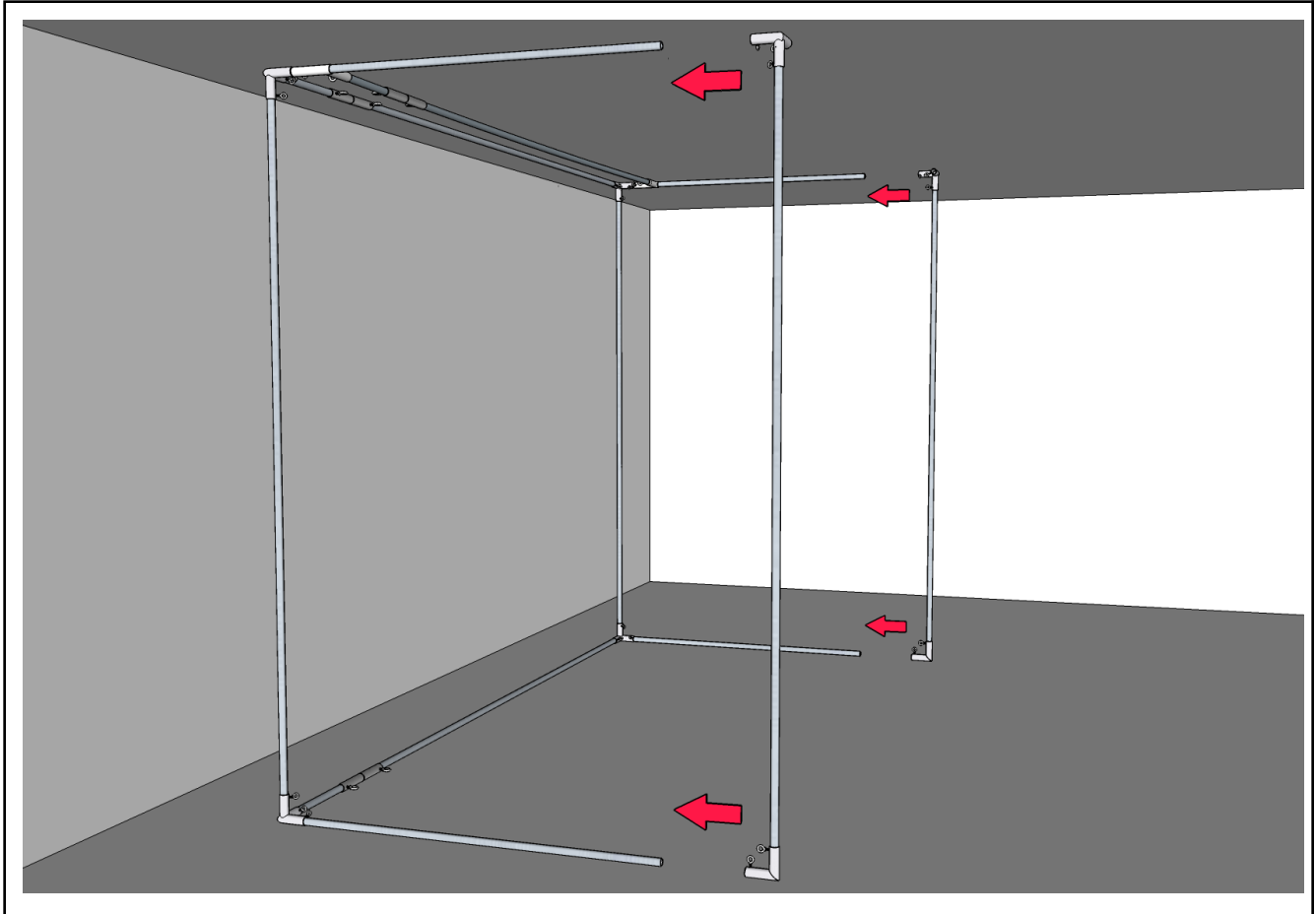

## Step 8 - Add Front Top Width Pole

Add the last width pole to the front of the enclosure.

**For SkyRailPlus™** configurations see SkyBridge™ [setup guide](#) for instructions on installing this pole at the front of the cage.

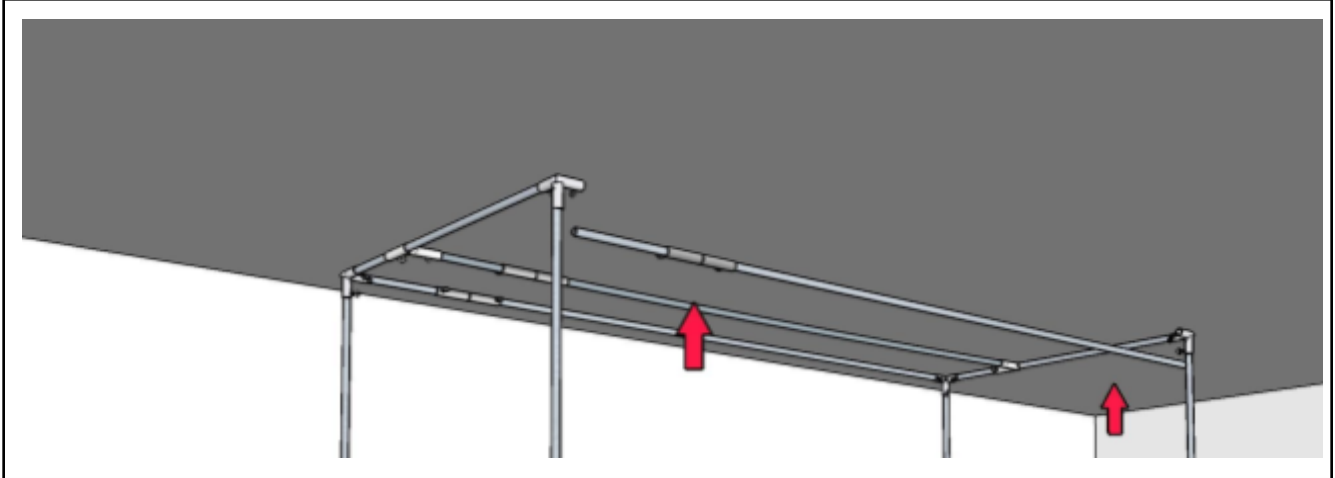

**Verify Dimensions:** Use a tape measure to verify the correct depth dimension and then tighten connectors. You may need to back the poles slightly out of the connectors to reach the correct dimension.

***This completes the special instructions for tight ceilings...***

## APPENDIX B - EMT POLE SCHEMATIC

